

MORLEY  **IAS**
FIRE SYSTEMS

by Honeywell

ZX1Se
ZX2Se
ZX5Se
ZX10Se

Document No.996-182-000-1, Revision 01

user
manual

Centaur Alarms Limited

Table of Contents

1	INTRODUCTION	1
1.1	NOTICE	1
1.2	WARNINGS AND CAUTIONS.....	1
1.3	NATIONAL APPROVALS.....	1
2	USER CONTROL LEVELS	2
2.1	LEVEL DEFINITION	2
2.2	USER PASSWORDS.....	2
3	CONTROLS AND DISPLAYS	3
3.1	CONTROL KEYS	3
3.2	FRONT PANEL LED INDICATIONS	4
3.3	ALPHANUMERIC DISPLAY INDICATIONS.....	6
3.3.1	<i>Normal Condition</i>	6
3.3.2	<i>Display Examples – Fire Alarms</i>	6
3.3.3	<i>Display Examples – Faults</i>	6
4	LEVEL 1 DISPLAY / CONTROL FUNCTIONS	7
4.1	NORMAL CONDITIONS	7
4.2	AC MAINS POWER FAIL CONDITIONS	7
4.3	FIRE ALARM CONDITIONS.....	7
4.3.1	<i>Override Delays</i>	7
4.4	FAULT CONDITIONS	7
5	LEVEL 2 CONTROL FUNCTIONS	8
5.1	POWER FAILURE CONDITION	8
5.1.1	<i>AC Mains Power Failure Indication</i>	8
5.1.2	<i>Battery Low / Charger Failure</i>	9
5.2	FAULT CONDITIONS	9
5.2.1	<i>Fault Indication</i>	9
5.2.2	<i>User Actions</i>	9
5.3	FIRE ALARM CONDITIONS.....	9
5.3.1	<i>Fire Alarm Indications</i>	9
5.3.2	<i>User Actions</i>	9
5.4	USER OPTION FUNCTIONS	10
5.4.1	<i>Test</i>	10
5.4.1.1	LED Test	11
5.4.1.2	LCD Test.....	11
5.4.1.3	Zones Test	11
5.4.1.3.1	<i>Configuring the Test</i>	11
5.4.1.3.2	<i>Terminating the Test</i>	12
5.4.1.3.3	<i>Inspecting Other Conditions During a Walk Test</i>	12
5.4.1.4	Output Test	13
5.4.1.5	Audible Indicator Test	14
5.4.2	<i>Time</i>	14
5.4.3	<i>Enable / Disable Functions</i>	14
5.4.3.1	Enable or Disable Zones.....	15
5.4.3.2	Enable or Disable Inputs	15
5.4.3.3	Enable or Disable Keys	16
5.4.3.4	Enable or Disable Delayed Day Modes.....	16
5.4.3.4.1	<i>Configure Day Mode Delay Period / Disable Operation</i>	17
5.4.3.4.2	<i>Manual Override</i>	17
5.4.3.5	Enable or Disable Outputs	17
5.4.3.6	Enable or Disable Delays.....	18
5.4.4	<i>Print</i>	18
5.4.5	<i>View</i>	19
6	DELAYED DAY MODE OPERATION	20

7	LEVEL 3 PROGRAMMER FUNCTIONS	21
8	LOG BOOK	22

Table of Figures

FIGURE 1 - ZX1SE & ZX2SE CONTROLS AND DISPLAYS	3
FIGURE 2 - ZX5SE & ZX10SE CONTROLS AND DISPLAYS	3
FIGURE 3 - SYSTEM CONTROL LED DISPLAY	4

Table of Tables

TABLE 1 - CONTROL KEY FUNCTIONS	3
TABLE 2 - ALPHANUMERIC AND INTERACTIVE CONTROL KEYS	4
TABLE 3 - LED FUNCTIONS	5
TABLE 4 - USER MENU OPTIONS	10
TABLE 5 - VIEW MODE OPTIONS	19
TABLE 6 – LOG BOOK REFERENCE DATA	22
TABLE 7 - LOGBOOK EVENT DATA	23

1 Introduction

1.1 Notice

- The material and instructions covered in this manual have been carefully checked for accuracy and are presumed to be correct. However, the manufacturer assumes no responsibility for inaccuracies and reserves the right to modify and revise this document without notice.
- These instructions cover the use and operation of the Fire Alarm Control Panel. Refer to the Installation Manual (P/N 996-174-000-X) for details of how to install the system and refer to the Commissioning Manual (P/N 996-175-000-X) for information on programming and Level 3 functions.
- The ZX1Se, ZX2Se, ZX5Se and ZX10Se Fire Alarm Control Panels are 1, 1-2, 1-5 and 1-10 loop panels for use with analogue addressable devices from the following detector manufacturer ranges:

For use with software version 834 onwards



1.2 Warnings and Cautions



These instructions contain procedures to follow in order to avoid injury and damage to equipment. It is assumed that the user of this manual has been suitably trained and is familiar with the relevant regulations.



All equipment is to be operated in accordance with the appropriate standards applicable

1.3 National Approvals

This equipment must be installed and operated in accordance with these instructions and the appropriate national, regional and local regulations specific to the country and location of the installation. Consult with the appropriate Authority Having Jurisdiction (AHJ) for confirmation of the requirements.

**EN54-2 13.7**

Maximum of 512 sensors / manual call points per ZX1/2/5Se panel; max of 1024 for the ZX10Se.

- The ZX1Se, ZX2Se, ZX5Se and ZX10Se range of panels has many features, which if used inappropriately, may contravene the requirements of EN54. Where such a possibility may arise, a suitable warning is given with brief details of the EN54 requirement and the relevant section it pertains to. A typical EN54 non-compliance warning is illustrated.

2 User Control Levels

2.1 Level Definition

- The ZX1Se, ZX2Se, ZX5Se and ZX10Se Fire Alarm Control Panels have three user control levels.
- At all three levels, the LED Displays indicate the condition of the installation, the Zone LED Displays indicate the location of any fire alarm or fault and the alphanumeric display gives more detailed fire alarm or fault information.
- At USER LEVEL 1, all the displays are functional but the front panel control keys are inhibited.
- At USER LEVEL 2, all front panel controls are functional and some system operation parameters and functions can be changed. User Level 2 is reached by entering a password from level 1.
- At USER LEVEL 3, all front panel controls are functional and full system configuration and programming is possible. User Level 3 is reached by entering a password from either Level 1 or Level 2. User Level 3 is intended for use by the system installer / maintenance contractor.

2.2 User Passwords

- Up to ten USER LEVEL 2 passwords can be programmed into the panel.
- The USER LEVEL 2 passwords can be assigned / changed at Level 3 by the installer / maintenance contractor. Level 2 passwords do not allow access to Level 3 functions.

3 Controls and Displays

3.1 Control keys

- The control panel has two groups of control keys.
- A bank of five keys contains the four system control keys: Sound Alarms, Silence / Resound, Mute, Accept and System Reset.
- A bank of 17 keys contains interactive and alphanumeric keys.

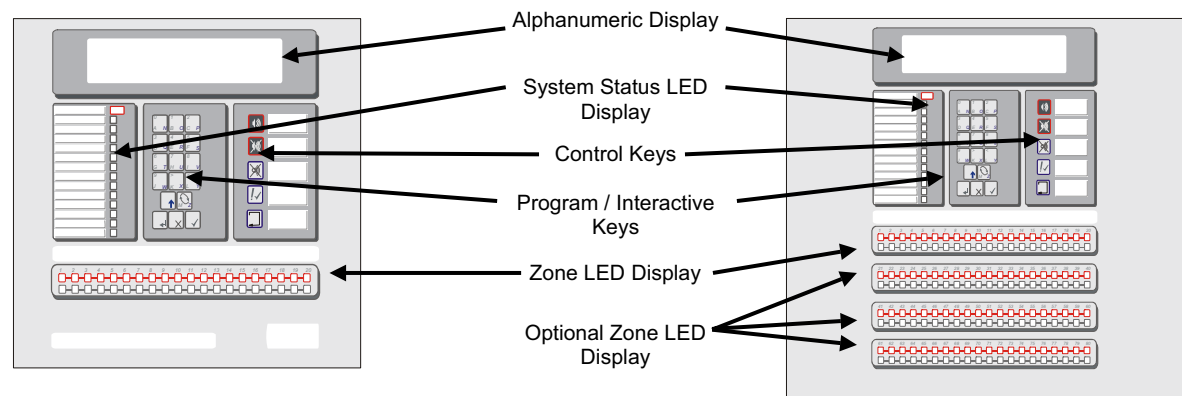

Figure 1 - ZX1Se & ZX2Se Controls and Displays

Figure 2 - ZX5Se & ZX10Se Controls and Displays





Key Legend	Symbol	Function
Sound Alarms		Press to Turn on ALL Sounder Outputs (i.e. evacuate building manually).
Silence / Resound		Press to Turn off all activated sounders. Press again to re-activate the sounders.
Mute Buzzer		Press to silence the internal buzzer.
Accept		Press to accept a Stage 1 Investigation Delay Alarm
System Reset		Press to cancel all alarm conditions and reset the panel.

Table 1 - Control Key Functions

- The alphanumeric keys normally function as a numeric keypad. During programming, these keys can be toggled to Letter Keys by pressing the CHANGE key. This gives access to letters A-M. For access to letters N-Z, press and hold the SHIFT key whilst pressing the appropriate letter key.





Key Legend	Symbol	Function
0 to 9		Press to enter numbers 0-9 or letters A-J (N-W with Shift)
>		Press to scroll through fire alarms or faults manually on the display or letter K (X with Shift)
<		Press to scroll back through fire alarms or faults manually on the display or letter L (Y with Shift)
Change		Press to change a display option (where allowed) or letter M (Z with Shift)
Enter		Press to confirm entry of a multiple digit number
No		Press to answer No, or terminate a display option
Yes		Press to answer Yes, or step through a display option
Shift		Press to show user options on the display Press, during programming, to allow entry of Letters N-Z

Table 2 - Alphanumeric and Interactive Control Keys

- The control keys are disabled at USER LEVEL 1. Pressing the SHIFT key will cause the display to prompt for entry of the Level 2 password. The password must be entered to re-enable the control keys at Level 2.

3.2 Front Panel LED Indications

- The Level 1 LED Indicators are divided into two sections.
- The upper array of LED Indicators shows the operational conditional of the panel and the installation.
- The lower array of Zone LED indicators shows the location of a fire alarm or fault.
- The standard Zone LED Indicators provide identification for up to 20 zones. On the ZX5Se and ZX10Se panels, this can be extended by adding either a further 20 zones (to give a total of 40 zones) or a further 60 zones (to give a total of 80 zones).
- The LED Indicators illuminate as red, yellow or green to give a clear indication of the panel status as follows:

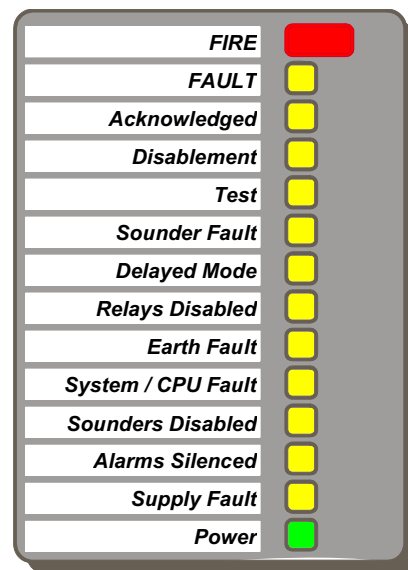

Figure 3 - System Control LED Display

Indicator	Colour	Function	What to do
FIRE	Red	The panel has detected a fire alarm condition, or the 'Sound Alarms' key has been pressed.	Once a false alarm has been confirmed correct the condition causing the alarm and then perform a panel reset.
Fault	Yellow	The panel has detected a fault. This condition latches even if intermittent.	Correct the condition causing the fault and then perform a panel reset. Call service engineer.
Acknowledged	Yellow	A fault or alarm has been accepted and the internal buzzer silenced.	Correct the condition causing alarm or fault and then perform a manual reset. NOTE: If another alarm or fault occurs the internal buzzer automatically resounds. See Fire and Fault above.
Disablement	Yellow	Part of the system, either input or output, has been disabled manually by the user.	Re-enable the device or devices. Refer to Disablement Function. Call service engineer.
Test	Yellow	The system is in test mode. Zone LED indicators show which zones are being tested.	Cancel test when finished. Enter test details in log book.
Sounder Fault	Yellow	This indicates a wiring fault with one of the sounder output circuits.	Call service engineer.
Delayed Mode	Yellow	This indicates that although an alarm has been detected, programmed system delays are currently stopping some outputs from operating.	Follow defined evacuation procedure. The delays may be enabled or disabled. Refer to Disablement Function.
Relays Disabled	Yellow	The relay outputs have been disabled.	Refer to Disablement Function.
Earth Fault	Yellow	An earth connection fault has occurred on a cable.	Call service engineer.
System / CPU Fault	Yellow	The CPU has reset or a system fault has occurred.	Call service engineer.
Sounders Disabled	Yellow	The sounder outputs have been disabled.	Refer to Disablement Function.
Alarms Silenced	Yellow	The sounder outputs have been silenced.0	See action required for Fire condition. NOTE: Press SILENCE / RESOUND again to reactivate the sounders. If a new alarm occurs, the alarms will resound.
Supply Fault	Yellow	There is a problem with the power supply, battery or supply input.	If mains failure wait for recovery then reset. If no mains failure call service engineer.
Power	Green	STEADY: Indicates AC Power is present. FLASHING: Indicates a loss of AC Power.	See Supply Fault. Should be lit - if flashing check isolator not open. Call service engineer.
Zone FIRE	Red	FLASHING: The zone is in a fire alarm condition.	See action required for Fire condition.
Zone Fault	Yellow	FLASHING: The zone contains faulty devices. STEADY: The zone is either disabled or in test mode.	Call service engineer. 1. Check TEST LED. 2. See Disablement

Table 3 - LED Functions

3.3 Alphanumeric Display Indications

- The alphanumeric liquid crystal display gives 160 characters of information on a 4-line display. The display is illuminated to assist viewing under dim ambient light conditions.
- When the numeric keypad is not in use, the display will revert to automatically scrolling through any fire alarm or fault conditions present on the panel. If there are no alarm or fault conditions, the display will show the date and time.
- Pressing the SHIFT key will show a list of optional functions or prompt for the level 2 password.

```

03-Mar-2007  11.38
All devices are within working limits
[Panel ACTIVE Control Keys INHIBITED] [1]
Do you want to enable the control keys?

```

3.3.1 Normal Condition

```

03-Mar-2007  11.38
All devices are within working limits
*****      Panel Name      *****

```

3.3.2 Display Examples – Fire Alarms

```

1 of 1 FIRE
ALARM RAISED FROM CONTROL PANEL [1]
ALARM SEQUENCE INITIATED (10S Elapsed)

```

This is the panel address number assigned to the panel in a network system.

```

1 of 1 FIRE
2 of 2 FIRE           MCP L2 A002   [1]
< - Zone Text - > < - Device Text - >

```

3.3.3 Display Examples – Faults

```

1 of 1 [1]
OPEN CIRCUIT ON SOUNDER B
For service phone (telephone no.)

```

```

2 of 8      No reply   L2 A001   [1]
< - Zone Text - > < Device Text - >
For service phone (telephone no.)

```

4 Level 1 Display / Control Functions

- At Level 1, the panel operates in a display only mode with the control keys disabled.
- If fire alarm or fault conditions exist, the LED Indicators will show these. Detailed information will be scrolled on the alphanumeric display. Note that the first 4 events will, in turn, be automatically scrolled on the display – other events can be reached using the manual scroll keys '<' & '>'.
> (forward) or the < (back) keys.

4.1 Normal Conditions

- When the system is in a normal condition, the green AC Power LED will be illuminated. The alphanumeric display will show the time and date and will alternate between a user programmed text message and a system status message.

4.2 AC Mains Power Fail Conditions

- If the AC Mains power source is interrupted, the AC Power LED will flash. In addition, the internal buzzer will sound.
- The back light illumination of the alphanumeric display will be turned off, the display will show an 'AC Fail' message and the Supply Fault LED and Fault LED Indicators will be lit.
- If both the AC Mains input and the Battery Standby Input fail then all LED and alphanumeric display indicators will be off.



The panel will display 'AC Fail' together with 'Battery Fail' and 'Charger Fail' under the following conditions:

1. When the panel is operating only on batteries that are in good condition; this gives the incorrect indication that the batteries are not serviceable.
2. Under very poor battery conditions but with a good mains supply present.

4.3 Fire Alarm Conditions

- If the control panel initiates an alarm condition, the FIRE LED Indicators will be illuminated and, if appropriate, the relevant ZONE FIRE LED Indicators will flash. The internal buzzer will sound and the alphanumeric display will give detailed information regarding the fire alarm location.
- If more than one fire alarm condition is present, the alphanumeric display will either automatically scroll through or, can be manually scrolled through, the fire alarms registered.

4.3.1 Override Delays

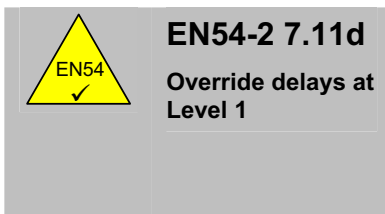

- If the ZX1Se, ZX2Se, ZX5Se and ZX10SE control panels are configured to operate with delays to outputs, a manual call point (MCP) will be located next to the panel.
- To override any delays and immediately activate the bells and other fire alarm output devices, break the glass in the call point.



4.4 Fault Conditions

- If the panel detects a fault, the FAULT LED is illuminated along with other appropriate system condition LED Indicators. The alphanumeric display gives detailed information regarding the nature of the fault and the panel buzzer will sound.
- If more than one fault condition is present, the alphanumeric display will either automatically scroll through or, can be manually scrolled through, the faults registered.

5 Level 2 Control Functions

- All of the functions and operational features described for Level 1 user are available and are the same for a Level 2 user.
- To enable Level 2 operation, press the SHIFT key. The display will then show:

```

03-Mar-2007  11.38
All devices are within working limits
[Panel ACTIVE Control Keys INHIBITED] [1]
Do you want to enable the control keys ?

```

- Press the **YES** key and the display will prompt for entry of the password.

```

03-Mar-2007  11.38
All devices are within working limits
[Panel ACTIVE Control Keys INHIBITED] [1]
Please Enter Password

```

- Enter the **4-digit Level 2 password**. The display then shows the Main Menu of user options. The top two lines of the display momentarily display 'keypad available for user access'. This is replaced with a 'SYSTEM NORMAL' message and details about the loops configured on the panel, unless any panel or system events exist where details about these are displayed instead.

```

[ Keypad available for user access ]
-----
[Active] 1)Commission  2)Test  3)Time [1]
4)Enable  5)Disable   6)Print  7)View

```

- If a key has not been pressed for a certain period, the display will revert to the normal Level 1 display showing the system status message. To re-show the menu display, press the **SHIFT** key.
- If a key has not been pressed for a specified period of time, (normally 5 minutes – programmable), then 'Level 2' access will be automatically cancelled. It will be necessary to re-enter the password to re-activate Level 2 functions.

5.1 Power Failure Condition

5.1.1 AC Mains Power Failure Indication

- If the AC Mains input is interrupted, the AC Power LED will flash and the panel buzzer will sound.
- The back light illumination of the alphanumeric display will be turned off, the alphanumeric display will show an 'AC Fail' message and the Supply Fault LED Indicator will be lit.
- If both the AC Mains input and the Battery Standby Input fail then all LED and alphanumeric display indicators will be off.
- To silence the panel buzzer, press the **MUTE BUZZER** key.
- When MUTED, the buzzer will continue to sound a short beep every 30 seconds. This gives an on-going warning of the continued AC Mains Failure condition.
- When the AC Mains is restored, the AC Power LED returns to steady on.
- To clear the latched AC Mains Fault, press the SYSTEM RESET key.

5.1.2 Battery Low / Charger Failure

- If the battery becomes disconnected the panel shows a 'Battery Missing' message. If the battery voltage is less than 21V DC or if there is a failure in the circuitry that charges the battery, then the panel shows a 'Battery Low / Charger Fail' message.

Note: Be aware, however, that the 'battery fail' message indication when displayed as a result of a confirmed battery charger failure should not be assumed to be correct.

- To silence the panel buzzer, press the **MUTE BUZZER** key.
- To clear the latched Fault, press the **SYSTEM RESET** key. If the fault is still present it will be redisplayed.

5.2 Fault Conditions

5.2.1 Fault Indication

- If the panel detects a fault, the FAULT LED is illuminated along with other appropriate system condition LED Indicators. The alphanumeric display gives detailed information regarding the nature of the fault and the panel buzzer will sound.

5.2.2 User Actions

- To acknowledge the event and to silence the panel buzzer, press the **MUTE BUZZER** key.
- With a fault still present pressing the **SYSTEM RESET** key will not clear the fault indication until the source of the fault is corrected. If necessary, the panel allows the disabling of individual points and zones.
- After correcting the problem, press the **SYSTEM RESET** key. The FAULT and other appropriate system status LED Indicators will be turned off. The alphanumeric display returns to normal mode.

5.3 Fire Alarm Conditions

- The panel will indicate a fire alarm condition if it detects an alarm condition or if the **SOUND ALARMS** key is pressed.

5.3.1 Fire Alarm Indications

- If the control panel initiates an alarm condition, the FIRE LED Indicator will be illuminated and, if appropriate, the relevant ZONE FIRE LED Indicators will flash. The internal buzzer will sound and the alphanumeric display will give detailed information regarding the fire alarm location.
- To test the alarm system, or to evacuate the building, press the **SOUND ALARMS** key. The panel will activate all the sounder output circuits, will illuminate the FIRE LED Indicator and the alphanumeric display will indicate 'ALARM SEQUENCE INITIATED' with a timer displayed to the right of this message indicating the elapsed time since initiation.

5.3.2 User Actions

- Press the **MUTE BUZZER** key to acknowledge the event and to turn off the internal buzzer.
- Press the **SILENCE / RESOUND** key to silence the sounder output circuits. The ALARMS SILENCED LED is turned on and this action is confirmed with 'ALARMS SILENCED' displayed on the LCD. Press the **SILENCE / RESOUND** key again to reactivate the sounder outputs.
- Press the **SYSTEM RESET** key to reset the system.

5.4 User Option Functions

```

03-Mar-2007  11.38
  All devices are within working limits
[ACTIVE]  1)Commission 2)Test  3)Time  [1]
4)Enable  5)Disable  6)Print  7)View
    
```

- The optional functions available to the user at Level 2 are as follows:

Function	Description
Commission	This option is not available to Level 2 users. It requires the entry of the Level 3 password before the programming mode can be entered.
Test	Allows the user to test parts of the system. The following tests can be performed: LEDs To test the LED indicator lamps. This test will automatically test each zone indicator and then terminate. LCD To test the alphanumeric display. ZONES To perform a 'Walk Test' on one or more zones. OUTPUTS To test the relay and sounder outputs connected to the system. This test is only available to Level 3 users. Audible Indicator To test the internal buzzer; a short beep is emitted.
Time	To change the date and time in the panel.
Enable	To enable zones, inputs, outputs, keys, delays and day mode operation.
Disable	To disable zones, inputs, outputs, keys, delays and day mode operation.
Print	To print various reports on an internal or remote printer.
View	To view devices and system status conditions.

Table 4 - User Menu Options

5.4.1 Test

- To display the Test Menu, press '2' and the display shows:

```

03-Mar-2007  11.38
  All devices are within working limits
1)LEDs  2)LCD  3)Zones  4)Outputs
5)Audible Indicator
    
```

- The test menu allows the user to test:
 - The LED's on the front panel display.
 - The alphanumeric (liquid crystal) display.
 - The detection and alarm initiating devices connected to the signalling loop.
 - The sounder outputs and other alarm condition output devices connected to the system.
 - The internal buzzer.

5.4.1.1 LED Test

- To select the option, press '1'.
- To terminate the test, press **No**.
- The panel will flash all of the indicators on the LED Display and will step through all of the Zone FIRE and FAULT indicators and then return to the menu after a period of approximately 45 secs.

5.4.1.2 LCD Test

- To select the option, press '2'.
- To terminate the test, press **No**.
- The alphanumeric display will flash all displayable characters in all positions of the display and then return to the menu.

5.4.1.3 Zones Test

5.4.1.3.1 Configuring the Test

- The 'Walk Test' option allows the user to conveniently test the detection and alarm initiating devices without having to continually reset the panel. During Walk Test the Test LED is lit.
- To select the option, press '3'.



If no action is taken at this point, the display will automatically revert to the normal display after 1 minute. Pressing SHIFT or '>' will return the display to the test display.

- The display will then prompt for whether the sounder outputs should ring:

```

03-Mar-2007  11.38
All devices are within working limits
Ring Bells?

```

- Press **Yes** and the sounders (dependent on their programming) will ring for a few seconds and then be reset automatically when a device is tested. (NOTE: Relay Outputs are never activated).
- Press **No** and the sounders will not ring.
- The panel can be set to test a range of zones. The display will prompt for the first zone to be tested:

```

03-Mar-2007  11.38
All devices are within working limits
Test from zone ?
( Key in number, then press "Enter" )

```

- Key in the number of the first zone to be tested. For example, for zone 12, press '**12 ENTER**'.
- The display then prompts the last zone to be tested:

```

03-Mar-2007  11.38
All devices are within working limits
Test from zone 12 ? to zone ?
( Key in number, then press "Enter" )

```

- Key in the number of the last zone to be tested. For example, for zone 15, press '**15**' and then '**ENTER**'.

- The Walk Test is then entered and the display will show a scrolling 'W' alternating with a 'Press No to Exit' on the bottom line:

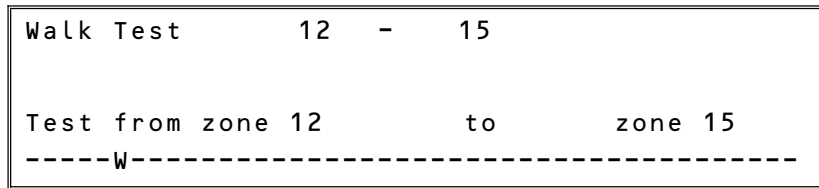

When panel is in Walk Test, the display will continue to show that walk test mode is active and the Test LED is lit. During Walk Test the bottom line of the display, every 10secs, will momentarily be replaced with 'Press "No" to Stop, ">" to enter Menus'. See Section 5.4.1.3.3.

- In the above example, any detector or initiating device going into alarm condition in zones 12, 13, 14 or 15 will:
 - Display an activation message on the alphanumeric display, write the event in the event log, sound the panel buzzer and illuminate the appropriate zone FIRE LED(s).
 - Turn on the LED at the sensor that initiated the alarm
 - After a few seconds, the panel automatically will be reset and the detector LED turned off. The panel is then ready to test the next detector. (Note: Up to 30 seconds is allowed for smoke detectors to clear).
- If an alarm signal is received from a zone other than those under test, then all sounder output and relay output circuits will activate as programmed for the zone in alarm. The sounders will continue to ring until silenced from the panel.

5.4.1.3.2 Terminating the Test



EN54-2 10.1 b

Walk Test:

- Press the 'NO' key to terminate walk test mode.

- On exiting the walk test function, the panel shows the following message for 20 seconds:

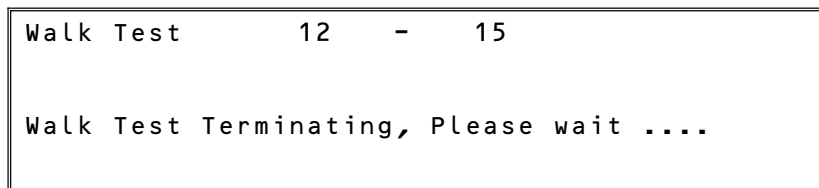

- This operation is to ensure that the test conditions (for example, smoke in the detector chamber) have cleared before returning the panel to normal operation, thereby avoiding unexpected fire alarm conditions.

5.4.1.3.3 Inspecting Other Conditions During a Walk Test



EN54-2 5.1

Display of functional conditions:

- To inspect Fire, Fault or Disablement conditions during a walk test, press the '>' key.

- During Walk Test press the '>' key. This re-displays the menu options in the lower half of the LCD. Select the View option from where other operating conditions can be inspected.

```

Walk Test      12      -      15

[ACTIVE]  1)Commission  2)Test  3)Time  [1]
4)Enable  5)Disable   6)Print      7)View
    
```

- To cancel the walk test, re-select the Test / Zones option. The display will then return to the normal walk test view, showing the current walk test in operation. For example:

```

Walk Test      12      -      15

Test from zone 12 to zone 15
-----W-----
    
```

- Then press the 'NO' key to cancel the test.

5.4.1.4 Output Test



Access to this test option is only available using the Level 3 password.

- To select the option, press '4' and then enter the Level 3 password '####'.
- To terminate the test, press **No**.
- The output test allows the relays and sounders to be individually operated. The first six outputs are reserved for the panel's own onboard relay and sounder circuits as shown below:

```

Output 1 – Onboard Relay 1
Output 2 – Onboard Relay 2
Output 3 – Onboard Sounder A
Output 4 – Onboard Sounder B
Output 5 – Onboard Sounder C      (Only available on ZX5Se / ZX10Se panels)
Output 6 – Onboard Sounder D      (Only available on ZX5Se / ZX10Se panels)
    
```

- On entering the test, the display will show the current state of the first output:

```

          03-Mar-2007  11.38
All devices are within working limits
RELAY      OPERATED
1
    
```

- To advance to the next output, press the '>' or the **YES** key. To go back keep pressing the '>' key until the desired option is displayed.

```

          03-Mar-2007  11.38
All devices are within working limits
RELAY      NOT OPERATED
2
    
```

- To change the output state, press the **CHANGE** key. The display will show the new state:

```

03-Mar-2007  11.38
All devices are within working limits
RELAY        OPERATED
2

```



The onboard sounder circuits are constantly monitored for correct end-of-line termination. A sounder error will be reported if one of the sounders is left in the operated test state for more than 5 seconds.

5.4.1.5 Audible Indicator Test

- To select the option, press '5'.
- The buzzer will beep once.

5.4.2 Time

- To change the date and time shown on the alphanumeric display, press '3' from the main user option menu.



On multi-panel systems, it is only necessary to change the time at the Master Panel. All of the other panels will synchronize their date and time to that of the master panel when a reset is performed on the master panel.

5.4.3 Enable / Disable Functions

- To select the enable or disable menu options, press '4' or press '5' as required from the user main menu. The display shows for each option:

```

03-Mar-2007  11.38
All devices are within working limits
ENABLE  1)Zone    2)Input  3)Keys
         4)Day Mode 5)Outputs 6)Delays

```

```

03-Mar-2007  11.38
All devices are within working limits
DISABLE 1)Zone    2)Input  3)Keys
         4)Day Mode 5)Outputs 6)Delays

```

- The options available in each menu are identical. This allows the user to enable or disable:
 - Zones
 - Individual input devices
 - Panel Keys
 - Day Modes
 - Outputs (Sounders or relays)
 - Delays
- To clear the entries from the display event history, press the 'SYSTEM RESET' button.

5.4.3.1 Enable or Disable Zones

- To enable or disable input devices by zone, select option 1.



Any loop driven output devices such as sounders or relay modules will still activate as programmed even if disabled. Only the input signal from these devices will be ignored.

- Press '1' and the display will prompt for the required zone number.

```

03-Mar-2007  11.38
All devices are within working limits
Disable Zone   ?
( Enter number or use ">" to scroll )

```

- Key in the zone number and then press the **ENTER** key. Or use the '>' key to scroll through the zones.

```

03-Mar-2007  11.38
All devices are within working limits
Disable Zone 14?  OK ?

```

- The display will then repeat the zone number and ask for confirmation (OK?). Press the **YES** key to confirm.
- The panel will enable or disable all of the input devices in the zone including smoke, temperature and call points.
- When a zone is disabled, the DISABLEMENT LED and the corresponding yellow Zone FAULT LED will be illuminated.
- If the panel is part of a network the following message will be temporarily displayed: 'Updating network, Please Wait...' before returning to the Status Normal message as in the above examples.

5.4.3.2 Enable or Disable Inputs

- To enable or disable individual input devices, select option 2.



Any loop driven output devices such as sounders or relay modules will still activate as programmed even if disabled. Only the input signal from these devices will be ignored.

- Press '2' and the display will prompt for the signalling loop circuit number where the device is located.

```

[ Keypad available for user access ]
-----
Loop  _

```

- Enter the required loop number (1 for ZX1Se, 1-2 for ZX2Se, 1-5 for ZX5Se or 1-10 for ZX10Se) and the display will prompt for the numeric address of the device:

```

03-Mar-2007  11.38
All devices are within working limits

Loop 2   Address  _ _ _

```

- Enter the address of the device required. If the address is less than 3-digits long (for example address 34), this can be entered as either 034 or 34 followed by ENTER.
- The display will then ask for confirmation (OK?).

```

03-Mar-2007  11.38
All devices are within working limits

Loop 2           Address 034  OK ?

```

- Press the **Yes** key to confirm.
- When an individual point is disabled, the DISABLEMENT LED will be illuminated.
- The corresponding Zone FAULT LED will only be illuminated if all devices in the zone are disabled.

Networked Panels

- Master panels are able to command other panels to enable or disable individual devices.
- In this case, the display will prompt with an additional, opening question requesting the panel (CPU) number.

```

03-Mar-2007  11.38
All devices are within working limits
CPU  _

```

- Enter the address of the required panel. The display will then prompt for the loop and device address information as described above.

5.4.3.3 Enable or Disable Keys

- To disable the panel control keys, press '3' from the disable menu.
- The user Level 2 password will then be required to re-enable the panel control keys and provide access to the User Option Functions.



The panel keys will automatically be disabled if a key has not been pressed for a pre-programmed period.

5.4.3.4 Enable or Disable Delayed Day Modes

- The Delayed Day Mode operation is configured at Level 3 by the installer / maintenance contractor.
- For example, the Delayed Day Mode may be set to be active between 8:00 and 17:00. Outside of these hours, a fire alarm condition will immediately sound the bells and activate outputs.
- The Delayed Day Mode causes the panel to respond to high sensor signals by sounding the panel buzzer and displaying a warning message on the alphanumeric display. The panel delays the activation of the alarm condition outputs (sounders or relays) for a programmed period.

- The user may enable or disable the operation of the Delayed Day Mode through the Enable or Disable Menu.
- To select Delayed Day Mode, press '4' from the Enable or Disable Menus. The display now presents two options:

Disable:

```

1 of 1 [n]
Output Delays Disabled
1)Disable the day mode delay period
2)Temporary override - Turn off delays

```

Enable:

```

1 of 1 [n]
Output Delays Disabled
1)Configure the day mode delay period
2)Temporary override - Turn on delays

```

5.4.3.4.1 Configure Day Mode Delay Period / Disable Operation

- To select configure or disable options, press '1'.
- When enabling the operation of the Delayed Day Mode function, the display prompts for the number of days the Delayed Day Mode is to be in operation.

```

03-Mar-2007 11.38
All devices are within working limits
Delay the alarms for the next 2 days

```

- If the prompted number of days is not as required, press the **CHANGE** key and then enter the required number of days.
- In the above example, the Delayed Day Mode will be effective for today and tomorrow. The day after tomorrow, the panel will go immediately into a full fire alarm condition on receiving a high signal from a device.
- The number of days can be selected in the range 001 to 199. To permanently enable the Delayed Day Mode operation, enter the number of days as 200.
- When Disable Day Mode Delay is selected, the Stage 1 / 2 Day Mode Delay Function is completely turned off.

5.4.3.4.2 Manual Override

- The manual override facility provides a means to override the scheduled time clock for operation of the stage 1 / 2 Day Mode Delay.
- If the Turn-On Delays option is selected, the Stage 1 / 2 function will be turned on immediately. It will automatically turn off again at the end of the next scheduled time.
- If the Turn-Off Delays option is selected, the Stage 1 / 2 function will be immediately turned off. It will automatically turn on at the start of the next scheduled time.

5.4.3.5 Enable or Disable Outputs

- All output devices (i.e. sounders and relays) can be disabled or enabled for test purposes.
- To enable or disable an output device, press '5' from the Enable or Disable menus.
- The display then shows a menu of the devices available and their current enable / disable status:

```

03-Mar-2007  11.38
  All devices are within working limits
1)Sounders   2)Relays
  ENABLED    ENABLED

```

- The DISABLEMENT and either the SOUNDERS DISABLED or RELAYS DISABLED LED indicators will be illuminated when the outputs are disabled. A warning message will also be shown on the alphanumeric display.
- The sounders can only be disabled after confirmation by re-entering the Level 2 password.

5.4.3.6 Enable or Disable Delays

- If the panel has been configured to operate with (pattern) phased evacuation or delays to specific outputs it is possible to enable or disable these delays.
- Select option “6” from the Enable or Disable menus.
- If disable delays is selected, the display prompts for entry of the Level 2 password to confirm.

```

03-Mar-2007  11.38
  All devices are within working limits
Disable ALL output delays:
Please enter password

```

- Enter the password.
- The display will briefly show one of the following messages to confirm the action taken before returning to the menu.

```

Disable ALL output delays:
Output delays disabled

```

- If enable delays is selected, the display after a short delay will return to the user main menu. If the panel is part of a network the following message is displayed for a short period first:

```

Updating Network, Please wait...
.....

```

5.4.4 Print

- To select the print menu, press ‘6’ from the user main, option menu. The display then shows:

```

03-Mar-2007  11.38
  All devices are within working limits
PRINT :  1)Devices 2)Events 5)Disabled
(  -  ) 3)Mode   4)Setup

```

- This menu controls the operation of the optional front panel printer on the ZX5Se and ZX10Se panels only. The user options are as follows:
 1. Devices: Prints out the present status and text assigned to all devices on a loop.
 2. Events: Prints out the contents of the event log.
 3. Mode: Sets the printing mode. The current mode of operation is shown on the display.
The possible modes are:
Manual - Prints on demand only
Auto - Automatically prints faults and fire alarms as they occur
- - The printer is turned off. Selecting the Print option when a printer is not fitted will display individual device data on the LCD.
 4. Setup: Sets the type of printer connected to the panel.
 5. Disabled: Prints a list of all disabled devices.



The printer Setup option can only be performed at Level 3 by an installer / maintenance contractor.

5.4.5 View

- To select the view menu, press '7' from the user main, option menu. The display then shows:

```

03-Mar-2007  11.38
All devices are within working limits
VIEW :  1)Devices  2)Log      3)Faults
        4)Outputs  5)Disablements  6)Sys. Events
    
```

- This menu allows the user to view information about the selected option on the alphanumeric display.
- After viewing an option, press **NO** to return to the view menu. From the view menu, press **NO** to return to the main options menu.
- The following View Mode Options are available:

View Option	Description of Function
1. Devices	Displays the status and text of anyone detector on a signalling loop. The panel prompts for the loop number and device address.
2. Log	Displays the contents of the event log. Events can be scrolled forwards or backwards using the '>' or '<' keys.
3. Faults	Displays the current panel fault status. The display is identical to the automatic fault / fire alarm display, but with the ability to manually scroll through all the faults using the > and < keys.
4. Outputs	Displays the required state of all output (sounder and relay) devices. Pressing the SILENCE / RESOUND key turns all sounders to an off condition.
5. Disablements	Displays a sub menu from which the following can be selected 1) Zones – Allows all zones that are in either a full or a partial state of disablement, to be viewed. 2) Inputs – Allows all inputs that are disabled, to be viewed. 3) Outputs – Allows all outputs that are disabled, to be viewed. NOTE) Pressing any button scrolls through the individual disablement conditions. Press 'NO' to return to the view menu.
6. Sys Events	The third line of the display shows the event number (1 – 800). The bottom line, immediately beneath the event number, shows whether the event is present (+) for non-latched events, (*) for latched events or (-) for inactive events.

Table 5 - View Mode Options

6 Delayed Day Mode Operation

- The panel can be configured to operate in a delayed day mode during the daytime for any specified zone.
- During this time, high sensor signals received from a detector will generate a fire alarm message on the panel but delay the ringing of the sounders. The panel will initiate a full fire alarm condition if no action is taken on this warning within a specified period.
- The use of delayed day mode must be configured at Level 3 by an installer / maintenance contractor before it is available for use at Level 2.
- The delayed day mode can be configured to only operate at specified times of the day and only in specified zones if required. The maximum time allowed to acknowledge stage 1 and stage 2 times can be programmed in intervals of one second.
- While the Delayed Day Mode function is in the active period the Delayed Mode LED will be illuminated.

Stage 1

- When a fire alarm condition is detected during delayed day mode, the internal buzzer will sound. The sensor location, together with a warning that the panel has entered stage 1 of a delayed alarm and a request to enter the stage 2 period, to allow a search to take place, will be displayed as below:

```

1 of 1 Fire Stage 1 L1 A067 [n]
Press ACCEPT key to start stage 2 timer.
Zone 2 Type ION
ALARM SEQUENCE INITIATED ( 10s elapsed )

```

- If the warning is not acknowledged, by not pressing **ACCEPT** within the time allowed for stage 1, then a full fire alarm condition will be raised and the sounder outputs will activate.
- Pressing **ACCEPT** within the time allowed will cause stage 2 of the delayed alarm. The Acknowledged LED is lit.

Stage 2

- The stage 2 timer commences counting down as soon as the panel receives the initial high signal from the detector. (i.e. it commences at the same time a stage 1 begins).
- Setting the stage 2 timer to a longer period than the stage 1 timer will allow the user to investigate the cause of the alarm and take appropriate action.
- If the panel is not reset, using the **SYSTEM RESET** key, within the time allowed then a full fire alarm condition will be raised and the sounder outputs will activate.



Manual Call Points (alarm boxes) will always generate an immediate fire alarm condition regardless of any delayed day mode settings.

7 Level 3 Programmer Functions

- Level 3 functions are for service engineer or installation company use only and, therefore, are not covered by this manual.

8 Log Book

- In accordance with best practice, the user should maintain a logbook to record all events resulting from or affecting the system. The logbook should be kept in a place accessible to authorized persons (preferably near the main panel).
- One or more identifiable individuals should be appointed to oversee or carry out all entries in the logbook. The names of the persons (and any changes of responsible person) should be recorded.
- All events should be properly recorded (events include real and false fire alarms, faults, pre-alarm warnings, tests, temporary disconnection's and service visits). A brief note of any work carried out or outstanding should be made.
- Sample pages of the logbook are provided here and can be photocopied to produce a suitable logbook. The sample below is for reference data (e.g. the name of the responsible person), while the sample on the next page is for the entry of event information.

REFERENCE DATA

Site Name and Address:	_____		
Site Telephone Number:	_____		
Responsible Person:	_____	Date	_____
	_____	Date	_____
	_____	Date	_____
	_____	Date	_____
The system was installed by:	_____		Date _____
And is maintained under contract by:	_____		
	_____		Until _____
Contact Telephone Number ¹ :	_____ if Service is Required.		

Table 6 – Log Book Reference Data

¹ This information should appear on the bottom line of the panel LCD when fault conditions have been detected.

EVENT DATA

Date	Time	Counter Reading	Event	Action Required	Date Completed	Initials

Table 7 - Logbook Event Data

NOTES



© MORLEY-IAS. All rights reserved.
© The MORLEY-IAS Logo is a registered trademark.

MORLEY-IAS Fire Systems, Charles Avenue,
Burgess Hill. West Sussex. RH15 9UF. England.
Web site: www.morleyias.co.uk

Centaur Alarms Limited